



**HETA**



 Made in Denmark

# Content

- 3 Cozy heat for living
- 4 Choosing the proper stove

## STOVE

- 6 Scan-Line 910 + 920B + 920S
- 9 HAC 2.0
- 10 Scan-Line 900
- 20 Scan-Line 800
  
- 38 We care about the environment
  
- 40 Scan-Line 8
- 44 Scan-Line 1000
- 48 Scan-Line 500 + Napoli + Turin
- 54 Scan-Line 7
- 57 Stone options
- 58 Ambition 4 + 5 + 8
- 60 Inspire
  
- 64 Scan-Line 40 + 50
- 66 Scan-Line 10 + 20 + 30
- 68 Scan-Line Tour
- 71 Stay warm for many hours
  
- 72 Scan-Line 95 + 100

## INSERT

- 74 Prestige
- 76 Panorama
- 78 Vista
- 80 Classic
- 81 Inspire
  
- 82 Builders hole measurements
- 85 Scan-Line 805 Aqua
- 88 HETA Automatic Combustion

## ACCESSORIES

- 89 Accessories for stoves
- 90 Glass plates

# Cozy heat for living.

## You get it all with HETA.

HETA is Danish design and quality, where we have catered for every detail. HETA stoves, inserts and pellet stoves offer a great source of heat in your home, add to the decor and spread cosiness on cold days. When you choose a HETA stove, you get cosy heat for living, peace of mind, Danish design and quality, developed over more than 150 years.

In Lemvig, on the west coast of Jutland, HETA is manufacturing all their stoves, inserts, pellet stoves, aqua stoves, thermal mass stoves and outdoor products in steel and cast iron, from idea to finished product.

We are constantly developing, updating and extending our impressive range of stoves. The craftsmanship and the pride of creating our own products are still the main characteristics of HETA, and these values are clearly reflected in our innovative and functional stoves.

We feel strongly about the environment and our common future. For many years, HETA has worked intensively on more environmentally-friendly production of wood-burning stoves, and today, they are some of the most clean-burning wood-burning stoves in Europe.

All HETA stoves have impressively high burning value, so you get more out of your firewood, and the amount of polluting gases is reduced as much as possible before they leave the chimney.

All stoves are inspected before leaving the factory. In addition to that, you naturally get a five year warrant on your product, covering manufacturer's defects.



# Choosing the proper stove

There is a large range to choose from and choosing the right stove is not so simple.

Before you decide, ask yourself the following five questions:



### **1. The size of your stove?**

Is your stove to be the primary source of heating or will it just provide a cozy atmosphere as a supplement to your present heat source? The answer is crucial for your choice of stove.

A stove's output is measured in kilowatts (kW). kW is an expression of the amount of heat given out by a stove. As a rule-of-thumb, 1 kW can warm up a 10-20 m<sup>2</sup> room with an average ceiling height, depending on the room's insulation. The value "kW tested" shows a stove's output has been tested in accordance with the European Committee for Standardisation's EN standard.

Be careful not to buy a stove with too many kW, the result may be that you use it with too little air supply so that the combustion is not optimum.

### **2. Radiation or convection?**

The majority of new stoves use convection, where air is circulated between an inner and outer steel mantle. When the air is heated it rises and heats the room. The convectional heat from a stove warms evenly, but requires a stove to be placed physically closer than a radiation stove. Therefore, you must consider where your stove should be installed. Radiation gives a more intense heat and will be suitable for small rooms.

### **3. Plate steel or cast iron?**

Both kinds of materials make excellent stoves and inserts. All HETA's products have both plate steel and cast iron. The allocation set according to durability and design.

### **4. Steel, ceramic, granite or soapstone?**

HETA has a wide selection of finishes from steel, casted tiles, ceramic, soapstone, limestone and sandstone cladding options are available, depending on the model you choose. The choice of material is a matter of style and design, though each material has particular characteristics. A stove made entirely from steel or cast iron warms up faster than a ceramics or stone and it also cools faster when the fire has gone out.

Ceramics and especially soapstone take a little longer to warm up, but stay warm long after the fire has gone out. The slightly larger soapstone stoves stay warm for many hours and can easily keep a room or house nice and warm through the night, so you will not wake up cold in the morning.

### **5. Which combustion technology should your stove have?**

For both financial and environmental reasons, you should always pay attention to how your wood-burning stove burns. Due to the completely unique dimensioning of the firebox and associated airways of HETA stoves, CO<sub>2</sub> and harmful particles are reduced as much as possible. HETA's modern combustion technology is extremely efficient and removes soot particles from the glass door and through the smoke channels. When you light up, a pleasant heat immediately radiates through the large glass panes, and then the convection system soon begins to distribute the heat and cosiness in the room and the adjacent spaces.

Scan-Line 910 + 920B + 920S

# Elite and Elegant



*Scan-Line 910  
Limestone*

Scan-Line 910, 920B and 920S are part of the Scan-Line 900 series. These models give an elite and elegant impression in your home. The 900 series have a large and robust fire chamber, together with an exceptionally beautiful combustion, which spreads good warmth and coziness.

These three models are available with 360° Soapstone, Greywood or Limestone, so you can clad your stove to suit your home's interior design. With an exclusive handle

and air control that are always pleasant to the touch, soft-close pull-out drawer that hides a 5-liter ash bucket and storage space for your glove or similar. On the entire Scan-Line 900 series you can choose a glass front that highlights the beautiful shapes of the stove and at the same time makes the stove more modern.

Heta's HAC 2.0 technology is available for the entire Scan-Line 900 series. See more about HAC 2.0 on page 9.

# Technical info

## Scan-Line 910 + 920S + 920B



Scan-Line 920S



Oven model	910	920B	920S	options
mm	<p>A: 258 Ø: 516 C: 1003 H: 1214</p>	<p>A: 258 Ø: 516 C: 1323 H: 1669</p>	<p>A: 258 Ø: 516 C: 1435 H: 1669</p>	 Greywood  Soapstone  Limestone
Floor to top outlet mm	1161	1449	1161	
Energy efficiency class	A+	A+	A+	
Nominal kW	6,8	6,8	6,8	
Weight kg	262	342	360	
Fuel volume kg	1,52	1,52	1,52	
Combustion chamber width mm	347	347	347	
Distance to flammable materials				
At the sides mm	400/425	400/425	400/425	
Behind stove mm	50/75	50/75	50/75	
Installed in a 45° corner	50/75	50/75	50/75	
Distance to furniture mm	1000	1000	1000	
Efficiency				
Ecodesign requirement of 75%	83	83	83	
Dust measurement				
Ecodesign requirement of 40 Mg/Nm³ 13% O₂	10	10	10	

With an impressive weight of 360 kg, the Scan-Line 920S with complete soapstone, will keep your home warm for many hours after the fire has gone out.



### Details



Integrated control handles



5 Liter ash bucket

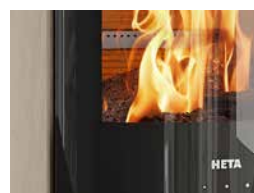

Glas door (optional)



Pull out drawer

More on [heta.dk](http://heta.dk)

 **HETA**

**Scan-Line 920B**  
Greywood



# HAC 2.0

Scan-Line 900 series & Icon-Line Moderna

 Made in Denmark

## Mobile app for Android and iOS

Heta's HAC 2.0 technology can be purchased separately and is easy to control using Heta's app for Android/iOS via Bluetooth.

HAC 2.0 is, first and foremost, a convenient aid in getting the highest possible heating value out of the firewood and, thus, the best possible value for money compared to manual operation. In addition, HAC 2.0 ensures against user error, as the temperature in the firebox will always be perfect.

An indicator is attached to the stove, which uses colour codes (red, yellow and green) to alert you if reignition is necessary or too much firewood has been loaded. The stove's door is equipped with a door sensor that registers when new firewood is added.



Scan-Line 900

# Exclusivity throughout

*Scan-Line 900  
glass door*



The Scan-Line 900 series is a stunning wood stove with sharp lines where nothing “disturbs” the eye. The exclusive set of handles that are hidden in the stove’s curves are designed for easy use and a unique silicone finish to keep them cool for your pleasure.

Scan-Line 900 is no ordinary wood stove, with its impressive large glass, single air control and optional self-closing door allowing you to enjoy the cozy flames in the large combustion chamber. The 900 is

a modern wood stove with all the HETA tradition, an integrated fireplace toolset and a large 5-liter ash bucket is nestled in behind the lower door.

The option of a glass door is available for all models in this impressive series, giving HETA’s 900 series modern, stylish design an eloquent look in any home.

**Scan-Line 900****Scan-Line 900**  
soapstone top**Scan-Line 900**  
soapstone**Scan-Line 900**  
glass door  
soapstone top**Scan-Line 900**  
blackwood top**Scan-Line 900**  
blackwood**Scan-Line 900**  
limestone top**Scan-Line 900**  
limestone



*Scan-Line 900B  
soapstone*

## Scan-Line 900B

With Scan-Line 900B or 900B with side windows, you can relax in the cozy, warm atmosphere while creating your favorite dishes in the baking oven. The large baking oven is equipped with an adjustable rack for convenience, it also has a unique feature which creates convection as well as removes condensation while baking your favorite dishes.

**Scan-Line 900B**



**Scan-Line 900B**



**Scan-Line 900B**  
soapstone top



**Scan-Line 900B**  
soapstone



**Scan-Line 900B**  
glass door + blackwood



**Scan-Line 900B**  
blackwood top



**Scan-Line 900B**  
blackwood



**Scan-Line 900B**  
limestone top



**Scan-Line 900B**  
limestone



## Scan-Line 900S

HETA's Scan-Line 900S or 900S with side windows, is the model for you if you're looking for the most out of your stove's heating capabilities. The Scan-Line 900S models have therma stones, they store the heat as you are firing in your stove. In the combination with one of the three stone finishes soapstone, blackwood or limestone, you will be heating your house for 10-12 hours after the fire has died out.

**Scan-Line 900S****Scan-Line 900S**  
soapstone top**Scan-Line 900S**  
soapstone**Scan-Line 900S**  
glass door + soapstone**Scan-Line 900S**  
blackwood top**Scan-Line 900S**  
blackwood**Scan-Line 900S**  
limestone top**Scan-Line 900S**  
limestone



## Scan-Line 900 side windows

With our selection of beautiful stones, you can make your stove a statement in your house like fine décor.

Choose from one of four finishes like soapstone, blackwood, limestone and steel on your Scan-Line 900 with or without side windows.

## Scan-Line 900 side windows



**Scan-Line 900**  
side windows  
glass door



**Scan-Line 900**  
side windows  
blackwood



**Scan-Line 900B**  
side windows



**Scan-Line 900B**  
side windows + glass door  
imestone top



**Scan-Line 900B**  
side windows  
soapstone



**Scan-Line 900S**  
side windows  
soapstone



**Scan-Line 900S**  
side windows  
blackwood top







**Scan-Line 900S**  
side windows  
limestone

# Technical info

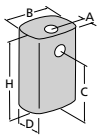
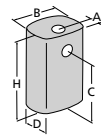
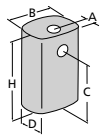
## 900 + 900B + 900S + side windows



Oven model	900	900B	900S	900 side windows	900B side windows	900S side windows	options
mm	 A: 181 B: 515 C: 1060 D: 421 H: 1191 / 1211	 A: 181 B: 515 C: 1330 D: 421 H: 1491 / 1511	 A: 181 B: 515 C: 1060 D: 421 H: 1491 / 1511	 A: 181 B: 515 C: 1060 D: 421 H: 1191 / 1211	 A: 181 B: 515 C: 1330 D: 421 H: 1491 / 1511	 A: 181 B: 515 C: 1060 D: 421 H: 1491 / 1511	 Soapstone  Blackwood  Limestone  Paint black/grey
Floor to top outlet mm	1167	1467	1167	1167	1467	1167	
Energy efficiency class	A+	A+	A+	A+	A+	A+	
Nominal kW	6,8	6,8	6,8	6,6	6,6	6,6	
Weight kg	147 → 201	177 → 243	214 → 298	147 → 186	177 → 227	214 → 264	
Fuel volume kg	1,52	1,52	1,52	1,71	1,71	1,71	
Combustion chamber width mm	347	347	347	347	347	347	
Distance to flammable materials							
At the sides mm	350	350	350	400	400	400	
Behind stove mm	175	175	175	150 / 125	150 / 125	150 / 125	
Installed in a 45° corner	100	100	100	200	200	200	
Distance to furniture mm	1000	1000	1000	900	900	900	
Efficiency Ecodesign requirement of 75%	83	83	83	82	82	82	
Dust measurement Ecodesign requirement of 40 Mg/Nm³ 13% O₂	10	10	10	11	11	11	

### Details



Integrated control handles



5 Liter ash bucket and fireside tool set



Glas door (optional)



Side windows

More on heta.dk



*Scan-Line 900  
soapstone*

**Scan-Line 800**



*Scan-Line 800*

## **Beautiful and convenient**

Scan-Line 800 is an ellipse-shaped stove in a smart and stylish design mainly in cast iron on the visible surfaces. Scan-Line 800 beautiful and convenient all at the same time.

Scan-Line 800 series comprises of six different variants at different heights. The models can be supplied with steel, soapstone, sandstone, blackwood, limestone or ceramic cladding.

Available is also accumulating large volumes of heat, a baking oven, swivel models and combustion chambers at different heights.

**Scan-Line 800****Scan-Line 800**  
soapstone top**Scan-Line 800**  
soapstone**Scan-Line 800**  
ceramic**Scan-Line 800**  
sandstone top**Scan-Line 800**  
sandstone**Scan-Line 800**  
blackwood**Scan-Line 800**  
limestone

**Scan-Line 810**

*Scan-Line 810  
limestone*



**Scan-Line 810****Scan-Line 810****Scan-Line 810**  
soapstone top**Scan-Line 810**  
soapstone**Scan-Line 810**  
ceramic**Scan-Line 810**  
sandstone**Scan-Line 810**  
blackwood**Scan-Line 810**  
limestone**Scan-Line 810**  
high top

**Scan-Line 820B**

# Visual attraction in your living room

If you choose Scan-Line 820B with soapstone you have ensured visual attraction in your living room and you can bake at the same time. Soapstone is a beautiful natural material with a fantastic heat accumulation and it stays warm long after the fire has gone out.

*Scan-Line 820B  
soapstone*



**Scan-Line 820B****Scan-Line 820B**  
soapstone top**Scan-Line 820B**  
soapstone**Scan-Line 820B**  
sandstone**Scan-Line 820B**  
limestone**Scan-Line 820B**  
blackwood**Scan-Line 820B**  
high top**Scan-Line 820B**  
ceramic

**Scan-Line 820S**

*Scan-Line 820S  
blackwood*



**Scan-Line 820S****Scan-Line 820S**  
soapstone top**Scan-Line 820S**  
soapstone**Scan-Line 820S**  
sandstone**Scan-Line 820S**  
limestone**Scan-Line 820S**  
ceramic**Scan-Line 820S**  
blackwood**Scan-Line 820S**  
high top

**Scan-Line 830 + 830S +  
830B + 840B + 840S**



*Scan-Line 830XL-B*

**Scan-Line 830 + 830S + 830B + 840B + 840S**

Scan-Line 830  
soapstone top



Scan-Line 830  
soapstone



Scan-Line 830XL-B  
soapstone



Scan-Line 830XL-B  
sandstone top



Scan-Line 840B  
ceramic



Scan-Line 840S



Scan-Line 840S  
blackwood top



Scan-Line 840S  
limestone top

**Scan-Line 850**



*Scan-Line 850 wall hanging  
blackwood top*



Scan-Line 850  
rotating pedestal



Scan-Line 850  
rotating pedestal  
soapstone top



Scan-Line 850  
rotating pedestal  
soapstone



Scan-Line 850  
rotating pedestal  
tobacco



Scan-Line 850  
rotating pedestal  
ceramic



Scan-Line 850  
wall hanging



Scan-Line 850  
wall hanging  
high top



Scan-Line 850  
rotating pedestal  
limestone top

**Scan-Line 800 side windows**

*Scan-Line 800M  
side windows*



**Scan-Line 800 side windows**

**Scan-Line 800M**  
side windows



**Scan-Line 820MS**  
side windows



**Scan-Line 820MB**  
side windows



**Scan-Line 800**  
side windows



**Scan-Line 820**  
side windows



**Scan-Line 820B**  
side windows



**Scan-Line 850M**  
rotating pedestal  
side windows



**Scan-Line 850M**  
wall hanging  
side windows

**Scan-Line 800M + 810M + 820MB + 820MS + 850M**

*Scan-Line 800M*



 **HETA** Scan-Line 800M + 810M + 820MB + 820MS + 850M



Scan-Line 800M



Scan-Line 810M



Scan-Line 820MB



Scan-Line 820MS



Scan-Line 850M  
rotating pedestal



Scan-Line 850M  
wall hanging

# Technical info

## 800 + 810 + 820B + 820S + 830 + 830B + 830S + 840B + 840S



Oven model	800	810	820B* + S	830	830B* + S	840B* + S	Options
mm	<p>A: 214 B: 547 C: 880 D: 440 H: 1043</p>	<p>A: 218 B: 547 C: 1162 D: 440 H: 1325 / 1357</p>	<p>A: 218 B: 547 C: 880 D: 440 H: 1325 / 1357</p>	<p>A: 218 B: 547 C: 880 D: 440 H: 1639</p>	<p>A: 218 B: 547 C: 880 D: 440 H: 1639</p>	<p>A: 218 / 214 B: 547 C: 1162 D: 440 H: 1639 / 1607</p>	<ul style="list-style-type: none"> <li> Soapstone</li> <li> Blackwood</li> <li> Limestone</li> <li> Tobacco</li> <li> Ceramic 42 colours</li> <li> Paint black/grey</li> </ul>
Floor to top outlet mm	1004	1286	1004	1383	1383	1286 / 1577	
Energy efficiency class	A+	A+	A+	A+	A+	A+	
Nominal kW	6,8	6,8	6,8	6,8	6,8	6,8	
Weight kg	113 → 200	130 → 238	137 → 285	190 → 366	190 → 366	S: 147 → 328 B: 159 → 290	
Fuel volume kg	1,5	1,5	1,5	1,5	1,5	1,5	
Combustion chamber width mm	330	330	330	330	330	330	
Distance to flammable materials At the sides mm	300	300	300	300	300	300	
Behind stove mm	125	125	125	125	125	125	
Distance to furniture mm	900	900	900	900	900	900	
Efficiency Ecodesign requirement of 75%	81	81	81	81	81	81	
Dust measurement Ecodesign requirement of 40 Mg/Nm <sup>3</sup> 13% O <sub>2</sub>	24	24	24	24	24	24	

\*Back outlet not possible Scan-Line 820B / 830B / 840B

### Details



8 Liter ash bucket



Fireside tool set



Optimal combustion



Baking oven

More on [heta.dk](http://heta.dk)

# Technical info

## 850 + 800 side windows + 800M + 810M + 820MB + 820MS + 850M



Oven model	850 wall	800 side windows	800M	810M	820MB*	820MS	850M	options
mm	 A: 242 B: 547 / 560 C: 516 D: 468 / 469 H: 682 / 711	 A: 214 B: 547 / 560 C: 880 D: 440 / 445 H: 1043 / 1075	 A: 214 B: 467 C: 880 D: 440 H: 1043	 A: 214 B: 467 C: 880 / 1162 D: 440 H: 1325	 A: 214 B: 467 C: 880 D: 440 H: 1325	 A: 214 B: 467 C: 880 D: 440 H: 1325	 A: 218 B: 467 C: 885 D: 445 H: 1035	 Soapstone  Blackwood  Limestone  Tobacco  Ceramic 42 colours  Paint black/grey
Floor to top outlet mm	640	1004	1004	1004 / 1286	1004 / 1295	1004 / 1295	996 / 1013	
Energy efficiency class	A+	A	A+	A+	A+	A+	A+	
Nominal kW	6,8	6	6,8	6,8	6,8	6,8	6,8	
Weight kg	102 → 158	119 → 128	113	122 → 137	137 → 285	137 → 285	112 → 168	
Fuel volume kg	1,5	1,5	1,5	1,5	1,5	1,5	1,5	
Combustion chamber width mm	330	330	330	330	330	330	330	
Distance to flammable materials At the sides mm Behind stove mm	300 125	450 130	340 125	340 125	300 125	300 125	300 125	
Distance to furniture mm	900	850	900	900	900	900	900	
Efficiency Ecodesign requirement of 75%	81	80	81	81	81	81	81	
Dust measurement Ecodesign requirement of 40 Mg/Nm³ 13% O₂	24	11	24	24	24	24	24	

\*Back outlet not possible Scan-Line 820MB

### Details



8 Liter ash bucket



Fireside tool set



Side windows



Baking oven

More on hetadk

# Effective combustion

The environment and our common future are very important to us. For many years, HETA has worked intensively on more environmentally-friendly production of clean-burning wood-burning stoves that place the least possible burden on the environment.

All HETA stoves have an impressively high degree of efficiency, so you get more out of your firewood, and polluting gases are burned off as much as possible before they leave the chimney.

HETA's stoves are some of the cleanest burning stoves in Europe. All ovens are tested according to current European standards and the new Ecodesign regulations. HETA's completely unique combustion chambers and airways mean that CO<sub>2</sub> and harmful particles are reduced as much as possible.

## What is Ecodesign?

The Ecodesign, is a regulation to ensure a wood stove conforms to the strict regulations in Europe. Since before Ecodesign, HETA has only developed and tested stoves to this standard, meaning any HETA stove sold today conforms to the Ecodesign standard. Giving you peace of mind when enjoying the cozy warm by your HETA wood, pellet or gas stove.

There is more to read on [heta.dk](http://heta.dk)





## HETA's combustion technology

HETA's combustion technology means that the combustion air flows easily and is supplied to the combustion without resistance. The preheated tertiary air supply burns a large amount of gases before the smoke goes up the chimney. Hot convection air is the air that is distributed into the surrounding rooms and, together with the radiant heat from the glass pane, constitutes the direct source of heat.

The heat is better exploited, and you can enjoy the view of the flames through the large glass window in the door - completely without soot.

The completely unique dimensioning of the fire chamber and associated airways of HETA stoves means that CO<sub>2</sub> and harmful particles are reduced as much as possible.

HETA's modern combustion technology is extremely efficient and removes soot particles on the glass door and through the smoke channels. When you light up, a pleasant heat immediately radiates through the large glass panes, and then the convection system soon begins to distribute the heat and cosiness in the room and the adjacent spaces.

Many of our products also have accumulation stones - soapstone, sandstone, granite or ceramic - that retain heat over many hours and slowly release it.

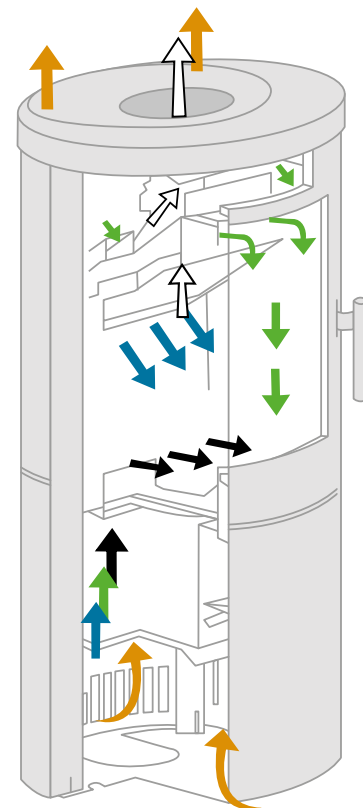

**Black** = primary  
**Green** = secondary  
**Blue** = tertiary  
**White** = flue gas  
**Orange** = convection air

## Scan-Line 8

# Small and smart

With its circular design, Scan-Line 8 generates attention in any home. Scan-Line 8 has a diameter of just 44 cm, a height of 100 cm and works well in many rooms in various different types of home. Scan-Line 8 is available in different materials and designs and has numerous smart functions.

With Scan-Line 8 you get an award-winning stove that has won the title of best wood-burning stove up to 5 kW at the Hearth & Home exhibition in England, as well as the Eco Stove Plus 2018 award due to the stove's low level of PM dust at 13% oxygen of  $< 3 / \text{m}^3$ .



Scan-Line 8  
soapstone / copper trims



**Scan-Line 8**  
casted sides  
silver trims



**Scan-Line 8**  
casted sides  
red trims



**Scan-Line 8**  
casted sides + soapstone top  
black trims



**Scan-Line 8**  
casted sides + soapstone top  
copper trims



**Scan-Line 8**  
soapstone  
black trims



**Scan-Line 8**  
soapstone  
silver trims



**Scan-Line 8**  
soapstone  
copper trims



**Scan-Line 8**  
soapstone  
red trims



Scan-Line 8  
grey



Scan-Line 8  
soapstone top



Scan-Line 8  
side windows



Scan-Line 8  
side windows  
soapstone top

## Technical info

### 8 + side windows



Oven model	8	8 side windows	Options
mm	<p>A: 222 B: 445 C: 875 D: 445 H: 1011 / 1029</p>	<p>A: 222 B: 445 C: 875 D: 445 H: 1011 / 1029</p>	Soapstone Paint black/grey
Floor to top outlet mm	981	981	Only soapstone top on side windows
Energy efficiency class	A+	A+	
Nominal kW	4,7	4,7	
Weight kg	100 → 135	105 → 110	
Fuel volume kg	1,1	1,1	
Combustion chamber width mm	300	300	
Distance to flammable materials At the sides mm Behind stove mm	350 120	400 100	
Distance to furniture mm	850	700	
Efficiency Ecodesign requirement of 75%	81	81	
Dust measurement Ecodesign requirement of 40 Mg/Nm <sup>3</sup> 13% O <sub>2</sub>	11	11	



### Details



5 Liter ash bucket  
Soft close



Air regulation  
and handle



Swivel plate  
and fresh air



Colored trims

More on heta.dk



*Scan-Line 8  
side windows  
soapstone top*

## Scan-Line 1000

# Accommodates pieces of wood up to 50 cm

Cannot be bothered chopping wood? Then Scan-Line 1000 must move in with you. HETA's large stove Scan-Line 1000 can accommodate large pieces of wood up to 50 centimetres.

HETA Scan-Line 1000 is robust without filling the room. The stove is built in heavy steel and cast iron and has almost unmatched possibilities for collecting and releasing heat. Behind the lower door you will find the large eight-litre ash pan and there is of course also your fireside tool set.

### Product data

---

- > 50 cm wood
- > Fireside tool set
- > 8 Liter ash bucket
- > Automatic closing



*Scan-Line 1000S  
soapstone*





Scan-Line 1000



Scan-Line 1000  
soapstone top



Scan-Line 1000  
soapstone



Scan-Line 1000  
blackwood top



Scan-Line 1000S



Scan-Line 1000S  
soapstone top



Scan-Line 1000B  
soapstone



Scan-Line 1000B  
blackwood

# Technical info



## 1000 + 1000S + 1000B

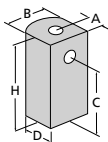
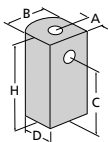
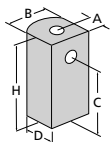

Oven model	1000	1000S	1000B
mm	 <p>A: 243 B: 767 C: 801 D: 476 H: 945 / 958</p>	 <p>A: 243 B: 767 C: 801 D: 476 H: 1292 / 1305</p>	 <p>A: 243 B: 767 C: 1166 D: 476 H: 1292 / 1305</p>
Floor to top outlet mm	919	919 / 1260	919 / 1260
Energy efficiency class	A+	A+	A+
Nominal kW	7,7	7,7	7,7
Weight kg	176 → 244	302 → 391	231 → 319
Fuel volume kg	1,8	1,8	1,8
Combustion chamber width mm	550	550	550
Distance to flammable materials			
At the sides mm	425	425	425
Behind stove mm	120	120	120
Distance to furniture mm	1300	1300	1300
Efficiency			
Ecodesign requirement of 75%	85	85	85
Dust measurement			
Ecodesign requirement of 40 Mg/Nm <sup>3</sup> 13% O <sub>2</sub>	11	11	11

>

**Options**

-  Soapstone
-  Blackwood
-  Paint black/grey

### Details



Integrated control handles



8 Liter ash bucket and fireside tool set



Large baking stove



Therma-stones

More on hetradk

## Scan-Line 500 + 510

# A choice of many models

Scan-Line 500 + 510 + 520B series is based on the steel models, available in 8 different versions.

These are supplemented by soapstone tops, complete soapstone, complete blackwood and ceramic models in 42 different colours, which can be freely combined just as you dream about.

The combustion chamber can accommodate a lot of wood, and the Scan-Line 500 series naturally meets all current regulatory requirements, thanks to HETA's modern combustion technology.

*Scan-Line 510  
soapstone*

## Product data

---

- > A choice of many materials and colours
- > Unrivalled combustion
- > Large and deep combustion chamber



**Scan-Line 500****Scan-Line 500**  
soapstone top**Scan-Line 500**  
soapstone**Scan-Line 500**  
ceramic**Scan-Line 510****Scan-Line 510**  
soapstone top**Scan-Line 510**  
soapstone**Scan-Line 510**  
blackwood



Scan-Line 520B  
soapstone



Scan-Line 520B  
blackwood



Scan-Line 520B  
ceramic



Scan-Line 520B



Scan-Line 520W  
ceramic



Turin  
soapstone



Turin B  
soapstone



Napoli  
soapstone

## Scan-Line Turin + Napoli

# HETA classics

Scan-Line Napoli and Scan-Line Turin are HETA classics. Both stoves have a generous soapstone or ceramic cladding. Scan-Line Napoli and Scan-Line Turin are available in as many as 42 different colours in the ceramic range. The soapstone provides extensive heat release over time.

### Product data

---

- > Beautiful ellipseshaped model
- > Choose among many different claddings
- > The soapstone provides extensive heat release over time

*Scan-Line Turin  
soapstone*



# Technical info

## 500 + 510 + 520B + 520W + 590 + Turin + Napoli



Oven model	500	510	520B* + W	590	Turin + Turin B*	Napoli	Options
mm	 A: 141 / 147 B: 504 / 570 C: 794 D: 468 / 498 H: 1010 / 1030	 A: 141 B: 504 C: 974 D: 468 H: 1190	 A: 141 / 147 B: 504 / 570 C: 794 D: 468 / 498 H: 1190 / 1210	 A: 148 B: 504 C: 794 D: 468 / 469 H: 1285 / 1295	 A: 157 B: 614 C: 836 D: 486 H: 1303	 A: 157 B: 614 C: 836 D: 486 H: 1057	 Soapstone  Blackwood  Ceramic 42 colours  Paint black/grey
Floor to top outlet mm	930	1110	1163	1285	1257	972	
Energy efficiency class	A+	A+	A+	A+	A+	A+	
Nominal kW	6	6	6	6	6	6	
Weight kg	108 → 185	115 → 214	134 → 229	135	186 → 268	142 → 213	
Fuel volume kg	1,24	1,24	1,24	1,24	1,24	1,24	
Combustion chamber width mm	340	340	340	340	340	340	
Distance to flammable materials							
At the sides mm	350	350	350	350	350	350	
Behind stove mm	150	150	150	150	150	150	
Distance to furniture mm	1000	1000	1000	1000	1000	1000	
Efficiency Ecodesign requirement of 75%	82	82	82	82	82	82	
Dust measurement Ecodesign requirement of 40 Mg/Nm <sup>3</sup> 13% O <sub>2</sub>	19	19	19	19	19	19	

\*Back outlet not possible Scan-Line 520B / Turin B

Only complete blackwood on Scan-Line 510 / 520B

### Details



8 Liter ash bucket



Cast iron door



Optimal combustion



Baking oven

More on [heta.dk](http://heta.dk)



Baking stoves

## Enjoy the smell and the heat at the same time

Your HETA stove can be used for more than just generating heat. The smell of freshly baked bread is divine, and by using HETA's modern thermal mass stoves and baking stoves you can take advantage of the heat and enjoy the smell in your living room. You can bake rolls, bread and cakes. You can also roast a chicken or a steak, make salty almonds and bake a pizza in your HETA baking stove and stay

warm at the same time. A HETA baking stove gives you unmatched possibilities and a unique food experience stimulating all your senses. Feel the heat from the large viewing window of the stove and enjoy the dancing flames. Listen to the mesmerising sound of burning wood, smell and taste the food. The stove's position as the hub of the room is intensified by the senses traveling.

## Scan-Line 7B

# Compact, modern design

Scan-Line 7 is available in many options from the traditional steel stove to a combination with either soapstone or blackwood. Scan-Line 7 can be wall-hung or mounted on a pedestal with a swivel function.

The Scan-Line 7 series is the perfect stove for smaller heating requirements.

*Scan-Line 7B  
soapstone*





Scan-Line 7B



Scan-Line 7B  
soapstone top



Scan-Line 7B  
soapstone



Scan-Line 7B  
blackwood



Scan-Line 7B  
log store



Scan-Line 7C  
soapstone top



Scan-Line 7D  
blackwood top  
rotating pedestal



Scan-Line 7L  
log store





# Technical info

## 7B + C + D + L

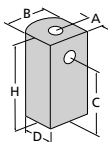
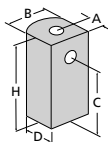
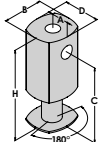
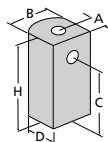

∨

Options

Oven model	7B	7C	7D	7L	
mm	 <p>A: 195 B: 462 / 470 C: 696 D: 415 H: 880</p>	 <p>A: 220 B: 462 / 470 C: 524 D: 440 H: 710</p>	 <p>A: 195 B: 462 / 470 C: 880 / 893 D: 415 H: 1063 / 1076</p>	 <p>A: 195 / 196 B: 462 / 470 C: 541 D: 415 / 416 H: 725 / 754</p>	 Soapstone  Blackwood  Point black/grey
Floor to top outlet mm	812	640	994 / 1013	656	
Energy efficiency class	A+	A+	A+	A+	
Nominal kW	4,5	4,5	4,5	4,5	
Weight kg	96 → 149	93 → 105	103 → 118	88 → 100	
Fuel volume kg	1	1	1	1	
Combustion chamber width mm	306	306	306	306	
Distance to flammable materials At the sides mm Behind stove mm	300 100	300 non flammable wall	300 100	300 100	Only complete blackwood on 7B
Distance to furniture mm	800	800	800	800	
Efficiency Ecodesign requirement of 75%	83	83	83	83	
Dust measurement Ecodesign requirement of 40 Mg/Nm <sup>3</sup> 13% O <sub>2</sub>	15	15	15	15	

## Details



8 Liter ash bucket



3 Liter ash bucket



Rotating pedestal



Optimal combustion

More on [heta.dk](http://heta.dk)

# Stone options

## Soapstone

Soapstone looks fascinating, but it also stores large inner values. Soapstone keeps the heat long after the fire has gone out. Soapstone releases the heat very slowly and consistent to the room. After only 2-3 fillings the slightly larger soapstone stoves keep the room heated for up to 14 hours, so you do not get up cold in the morning. Soapstone is a 3 billion years old mineral available in different hardness and colours. HETA's soapstone is grey, but due to the fantastic play of colours not two stones are identical.

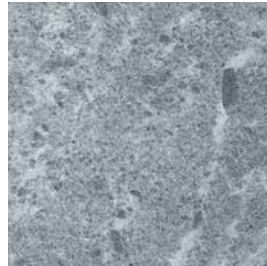

*Soapstone is available for Scan-Line 900 / 900 side windows series, Scan-Line 800 series (not M models), Scan-Line 800 side windows models only the top (not M models), Scan-Line 500 series, Scan-Line 7 series, Scan-Line 8 series, Scan-Line 1000 series, Scan-Line 80 series, Scan-Line 40/50, Scan-Line 10, 20, 30, Scan-Line Green 250/150, Napoli and Turin.*

## Sandstone and Blackwood

Sandstone keeps the heat long after the fire has gone out. Sandstone also gives your stove character. Sandstone is available in many different colours. Some sandstone looks like wood with structure and grains. HETA's sandstone comes from the Himalaya mountains at around the 2900 meters elevation. Sandstone is a fine-grained natural stone tied together by quartz sand. The fantastic play of colours in the stone comes from compaction through billions of years and surface flow. Thus, not two stones are equal.

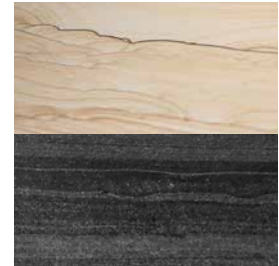

*Tobacco sandstone is available for Scan-Line 800 series (not M models), Scan-Line 800 side windows models only the top (not M models), Scan-Line Green 250. Blackwood is available for Scan-Line 800 series (not M models), Scan-Line 800 side windows models only the top (not M models), Scan-Line 1000 series, Scan-Line Green 250, Scan-Line 900 / 900 side windows series, Scan-Line 510/520B complete blackwood only and Scan-Line 7B.*

## Ceramic

Ceramic tiles keep the heat long after the fire has gone out. The tiles also give your stove character. You can choose among 42 different colours. You can combine the colours to precisely suit your wish and your housing style.

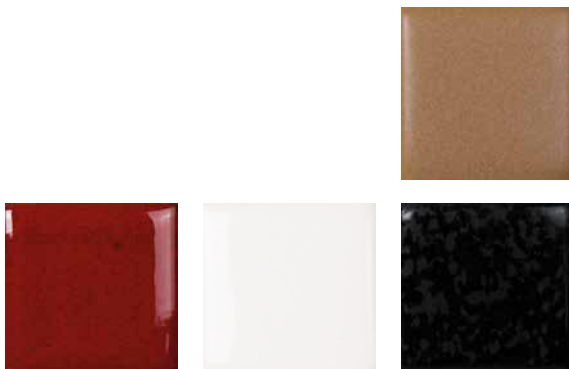

*Ceramic tiles are available for Scan-Line 800 series, Scan-Line 500 series, Scan-Line Tour 10, 20, 30, Napoli and Turin.*

## Limestone

Limestone is a natural stone crafted over millions of years. Limestone has been used throughout the ages, from buildings to sculptures and now it is available on selected HETA stoves and pellet stoves. HETA's Limestone will give your stove a unique appearance, as well as hold the heat from the fire, releasing it slowly after the fire has gone out. Limestones Travertine like appearance, is stylish and timeless, fitting perfectly into your homes design.



*Limestone is available for Scan-Line 800 (not M models), Scan-Line 800 side windows models only the top (not M models), Scan-Line Green 250, Scan-Line 900 series.*

## Ambition 4 + 5 + 8



Ambition 5

# Enjoy the flames

Sit back relax and enjoy your wood burning experience with a HETA Ambition 4, 5 or 8. Featuring a larger glass for viewing the mesmerizing flames. HETA's Clean Burn combustion controlled by a single lever, giving you superior control.

The Ambition 5 and 8 also has an easy to assemble log store, that can be purchased separately. Giving you the option to enjoy this impressive stove in any house.



**Ambition 4**



**Ambition 4  
log store**



**Ambition 5**



**Ambition 5  
log store**



**Ambition 8**



**Ambition 8  
log store**

Inspire 40 + 45 + 55

# A versatile stove

Inspire has clean lines and exquisite materials and is ideal in any home and decor. Inspires are perfect for small, modern rooms and traditional country cottages or cabins. The Inspires combustion is very easy to control and combustion performance is excellent from as low as 3 kW.

The wide combustion chamber in Inspire 55 and Inspire 55 high gives a beautiful panoramic view of the flames plus lots of room for the wood. The large glass window provides extensive heat release to the room and makes Inspire 55 a very versatile stove. Inspire 55 is available with integrated log store.

## Product data

- > 50 cm wood
- > Available as high and low series

Inspire 55





Inspire 40



Inspire 45



Inspire 55



Inspire 40  
log store



Inspire 45  
log store



Inspire 55  
log store



## Inspire 55HK

# With cooking plate



The Inspire 55H with cooking plate, is a stove for heating and cooking. The highlight is the 42 x 16 cm polished and raised cooking plate, which is integrated in the top plate and offers space for several pots. On this you can boil water and prepare all delicious dishes, like on a kitchen stove.

The Inspire 55H with cooking plate is not only a wonderful heat source, but can also be used as a cooking area.

The large viewing window offers a cozy atmosphere, rounded off by a built in wood storage compartment.

# Technical info

## Ambition 5 + 8 + Inspire 40 + 45 + 55 + 55HK

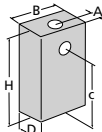
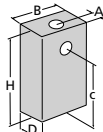
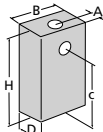
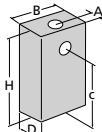
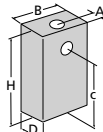
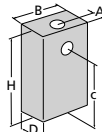
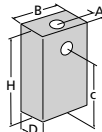

Oven model	Ambition 4	Ambition 5	Ambition 8	Inspire 40	Inspire 45	Inspire 55	Inspire 55HK
mm	 A: 138 B: 440 C: 497 D: 342 H: 600	 A: 138 B: 550 C: 516 / 817 D: 348 H: 619 / 920	 A: 138 B: 550 C: 516 / 817 D: 418 H: 619 / 920	 A: 113 B: 460 C: 467 / 737 D: 367 H: 585 / 855	 A: 116 B: 540 C: 451 / 751 D: 377 H: 555 / 855	 A: 133 B: 652 C: 451 / 807 D: 406 H: 555 / 920	 A: 133 B: 652 C: 807 D: 406 H: 920
Floor to top outlet mm	606	619	619	596 / 866	566 / 866	565 / 921	920
Energy efficiency class	A+	A+	A	A+	A+	A	A
Nominal kW	3,9	4,9	6,5	4,5	4,9	6,3	6,3
Weight kg	76	100 → 115	110 → 131	78 → 96	89 → 109	101 → 134	137
Fuel volume kg	0,8	1,2	1,8	1,1	1,2	1,5	1,5
Combustion chamber width mm	358	468	478	370	424	560	560
Distance to flammable materials							
At the sides mm	400	400	400	340 / 400	300 / 300	420	420
Behind stove mm	275 / 175	200	225	120 / 190	195 / 150	220 / 150	220 / 150
Distance to furniture mm	950	1100	1100	900	860	1200	1200
Efficiency Ecodesign requirement of 75%	81	85	80	81	84	80	80
Dust measurement Ecodesign requirement of 40 Mg/Nm³ 13% O₂	15	18	23	28	15	30	30

options



Soapstone

Paint black/grey

Only soapstone top Inspire 45

### Details



Quality cast iron



Air regulation



Top outlet



Cooking plate

More on [heta.dk](http://heta.dk)

**Scan-Line 40 + 40B + 50 + 50B**

# Clean lines

Scan-Line 40 + 50 attracts attention with its beautiful strong design. You can use Scan-Line 40 + 50 as a traditional stove and it will heat a room up relatively quickly. Or you can close off the convection and use the thermal mass principle, allowing the 500 kg of soapstone to slowly release the heat over many hours.

## Product data

- > Strong design
- > Generates heat for many hours
- > Perfect combustion
- > Available in Blackwood or Soapstone



*Scan-Line 40*



## Technical info

### 40 + 40B + 50 + 50B



Scan-Line 40  
blackwood



Scan-Line 40B  
soapstone



Scan-Line 50  
soapstone



Scan-Line 50B  
soapstone



Oven model	40 + B	50 + B	options
mm	<p>A: 199 B: 530 C: 929 / 1444 D: 450 H: 1614</p>	<p>A: 199 B: 530 C: 929/1444/1959 D: 450 H: 2133</p>	Soapstone Blackwood Paint black/grey
Floor to top outlet mm	1067 / 1300	1067 / 1300	
Energy efficiency class	A+	A+	
Nominal kW	6	6	
Weight kg	447 → 445	536 → 547	
Fuel volume kg	1,25	1,25	
Combustion chamber width mm	336	336	
Distance to flammable materials			
At the sides mm	350	350	
Behind stove mm	150	150	
Distance to furniture mm	1000	1000	
Efficiency			
Ecodesign requirement of 75%	82	82	
Dust measurement			
Ecodesign requirement of 40 Mg/Nm <sup>3</sup> 13% O <sub>2</sub>	19	19	

## Details



8 Liter ash bucket



Pull out drawer

More on [heta.dk](http://heta.dk)

**Scan-Line 10 + 20 + 20B + 30 + 30B**

# Two in-one stove

Scan-Line 20B/30B is a modern thermal mass stove. You will heat a room up relatively quickly and then the 450-614 kg of soapstone and thermal stones will slowly release the heat over many hours. Allowing you to get a longer heating period out of your stove.

## Product data

---

- > Round design
- > Generates heat for many hours
- > Can also be used as a traditional stove

*Scan-Line 30B*





Scan-Line 10



Scan-Line 20



Scan-Line 20B



Scan-Line 30



Scan-Line 30B

Scan-Line 30B  
high

**Scan-Line Tour 10 + 20 + 30**

# Top-class quality

Scan-Line Tour 10, 20 and 30 can all be equipped with extra heat accumulating stones inside the beautiful ceramic tiles. The combination of convection air, the accumulation of heat in ceramics and the heat accumulating stones, in all three models. This means that you both get the spreading of heat while the stove burns and then storage of heat released overnight.

## Product data

---

- > Throughout quality
- > Sensational design
- > Generates heat for many hours

*Scan-Line Tour 30*





Scan-Line Tour 10



Scan-Line Tour 20







Scan-Line Tour 30

# Technical info

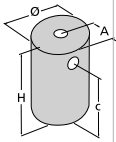
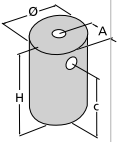
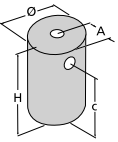
## 10 + 20 + 20B+ 30 + 30B + Tour 10 + Tour 20 + Tour 30

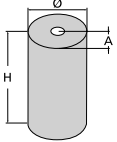
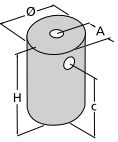
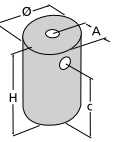

Oven model	10	20 + B	30 + B	Options	Tour 10	Tour 20	Tour 30	Options
mm	 A: 256 / 263 Ø: 632 C: 1068 H: 1261	 A: 256 / 263 Ø: 632 C: 1068 / 1330 H: 1523	 A: 256 / 263 Ø: 632 C: 1068/1330/1592 H: 1785	 Soapstone  Paint black/grey	 A: 310 Ø: 620 H: 1380	 A: 310 Ø: 620 C: 1298 H: 1684	 A: 310 Ø: 620 C: 1602 H: 1988	 Ceramic 42 colours  Paint black/grey
Floor to top outlet mm	952	952	952		978	978	978	
Energy efficiency class	A+	A+	A+		A+	A+	A+	
Nominal kW	6	6	6		6	6	6	
Weight kg	412	505	566		254	292	330	
Fuel volume kg	1,6	1,6	1,6		1,24	1,24	1,24	
Combustion chamber width mm	336	336	336		340	340	340	
Distance to flammable materials At the sides mm Behind stove mm	350 150	350 150	350 150		350 150	350 150	350 150	
Distance to furniture mm	1000	1000	1000		1000	1000	1000	
Efficiency Ecodesign requirement of 75%	82	82	82		82	82	82	
Dust measurement Ecodesign requirement of 40 Mg/Nm³ 13% O₂	19	19	19		16	16	16	

### Details



Ash bucket



Beautiful ceramic tiles



Optimal combustion



Baking oven

More on [heta.dk](http://heta.dk)

Thermal mass stoves

# Stay warm for many hours

Draw admiring glances while you stay warm! HETA's exclusive thermal mass stoves draw generate attention and fulfil all your wishes. You can use the thermal mass stove as a traditional stove with quick heating, or you can take advantage of the thermal mass stove and let it release the heat slowly over many hours.

By having a HETA thermal mass stove in your home you also save wood, as our thermal mass stove stores the heat for up to 18 hours. Our therma-stones are made of a special material based on concrete which absorb the heat particularly well and release the heat over a longer period.

There is more on [heta.dk](http://heta.dk)



Scan-Line 1000S

Scan-Line 800  
therma-stones

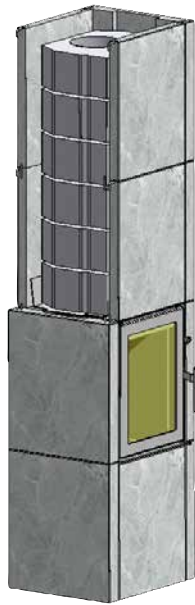

Scan-Line 50



Scan-Line 830S

## Comparing therma capacity

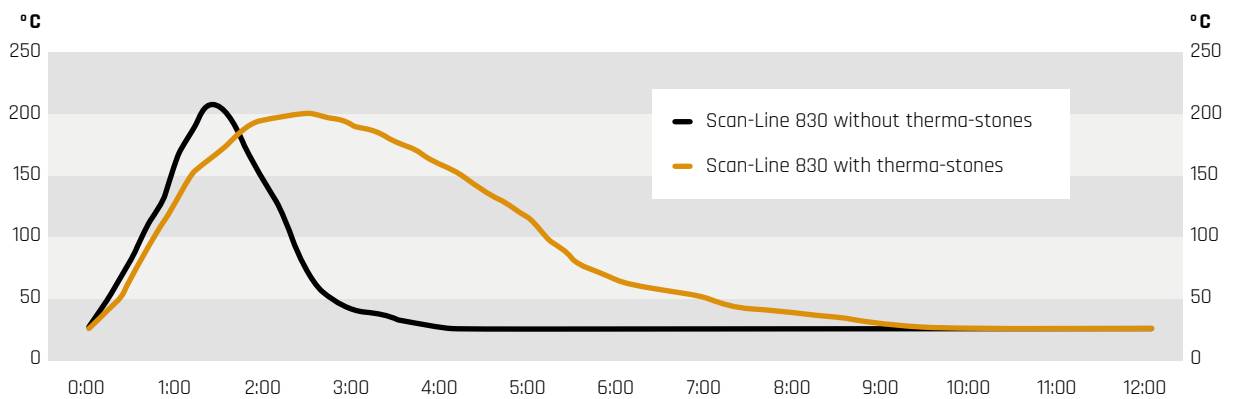

## Scan-Line 95 + 100

*Scan-Line 95H*

# Spread the coziness

Scan-Line 95 + Scan-Line 100 are beautiful and give extensive heat release and coziness. The stove seems almost to float on air and if you choose the model with swivel pedestal you can spread the heat and mesmerising coziness exactly where you want it. The unique and new combustion technique provides an amazing combustion.

## Product data

- > Panoramic view of the flames
- > Elegant closing mechanism
- > Fantastic combustion



Scan-Line 95



Scan-Line 95H  
log store



Scan-Line 95  
rotating pedestal



Scan-Line 100  
rotating pedestal



Scan-Line 100  
short bench



Scan-Line 100  
long bench



Options

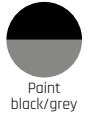

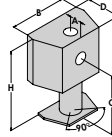
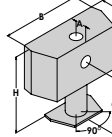
Oven model	95	100
mm	 A: 151 B: 760 C: 739 / 764 D: 433 H: 1007 / 1022	 A: 151 B: 1019 C: 742 D: 433 H: 1007 / 1023
Floor to top outlet mm	943 / 965	883 / 901
Energy efficiency class	A	A+
Nominal kW	7,2	9,9
Weight kg	142	172
Fuel volume kg	1,9	2,3
Combustion chamber width mm	548 / 462	808 / 730
Distance to flammable materials		
At the sides mm	350	250
Behind stove mm	150	100
Distance to furniture mm	1100	1200
Efficiency Ecodesign requirement of 75%	80	81
Dust measurement Ecodesign requirement of 40 Mg/Nm <sup>3</sup> 13% O <sub>2</sub>	29	17

Prestige A + B + C

# Clean and strong design

Prestige matches modern interior design and having windows on up to three sides you can enjoy the view of the flames from all angles. Prestige is available in four different models. You get an elegant solution in your home no matter which model you choose. The design is clean and strong and matches modern interior design.

All visible sides are made from cast iron and at the same time, the frames around the convection box can be customized. The door is opened and closed soundless with the discrete handle, and you can decide on which side the handle is placed.

*Prestige C*



## Product data

---

- > Can be customized
- > Optional windows on three sides



Prestige A



Prestige BR



Prestige BL



Prestige C



## Panorama + Panorama XL

# Almost like a painting

Panorama gives you an exceptional panoramic view of the flames. The fire insert is easy to operate, and the large, stylish panoramic window with an almost hidden control handle is beautiful and looks almost like a piece of art hanging on the wall.

Panorama is available with customized front frames that fits into your home precisely.

### Product data

---

- > Modern design
- > Hidden control handles
- > Can be customized



Panorama



Panorama XL



## Vista

# Modern and compact

HETA's Vista insert is a modern compact insert, with a panoramic view of enchanting flames through the wide glass door. With HETA's signature single air control, Vista's combustion is easy to control, giving you the heat or cozy atmosphere, you desire.

Along with ease of control the Vista has a stylish integrated door handle and self-latching door, making lighting and re-fueling your Vista enjoyable.

Vista is the perfect insert for new homes and designed to be placed in most existing open fireplaces,

its measurements are as follows Width 694 mm, Height 489 mm and Depth 453 mm.

You have the option of a stylish frame, custom frame or installing it frameless, thanks to the Vista's 3 mm ridged convection case.

If your installation requires direct air, an optional fresh air connector can be purchased separately.



Vista



Vista S

## Classic 1



Classic 2

# Beautiful view of the flames

Classic with its clean lines merges into the modern and stylish home. You have a beautiful view of the flames through the panoramic window.

## Product data

---

- > Modern design
- > Hidden control handles
- > Panoramic window



Classic 1

Inspire 40 insert



# Small and robust

Enjoy the flames in our trendy fire inserts Inspire or Scan-Line 550. HETA's combustion technique, controlled by one single handle, gives you a perfect view through the clear portrait window. Inspire and Scan-Line 550 are the perfect choices for smaller rooms or a cozy moment.

## Product data

---

- > Small and high
- > Good for smaller rooms



Inspire 40  
floor



Inspire 40  
floor



Inspire 40  
wall



Inspire 40  
wall



# Builders hole measurements

## Vista

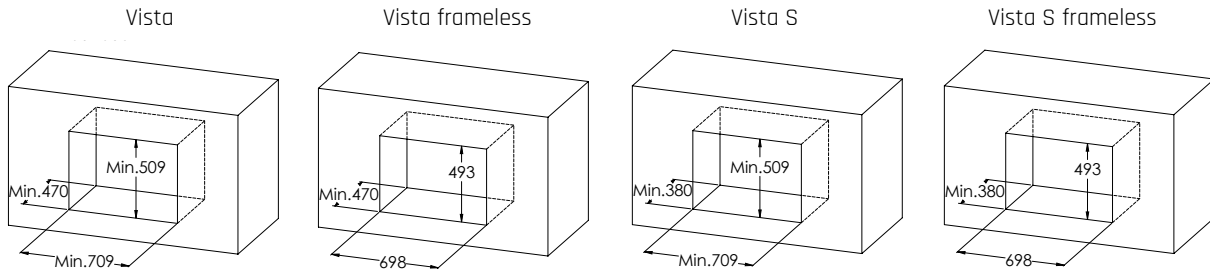

## Prestige

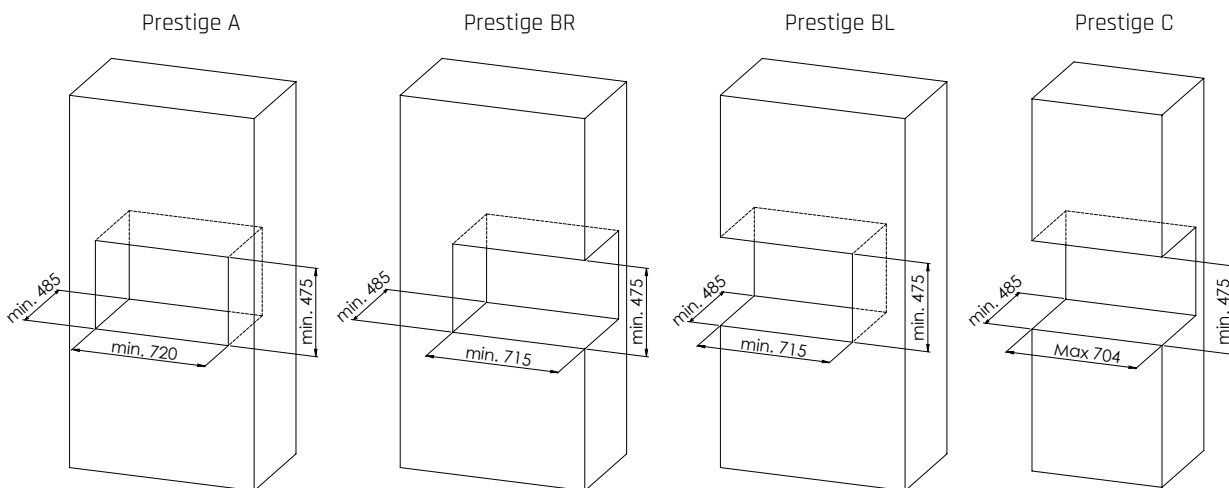

## Panorama

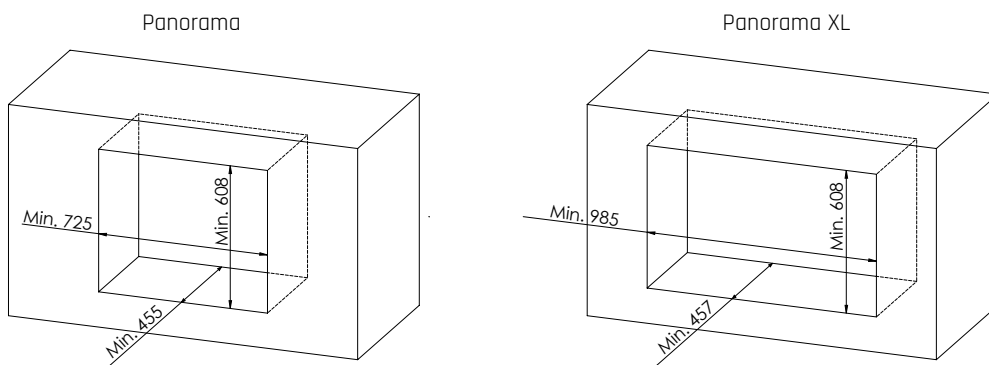

## Classic

---

Classic 1

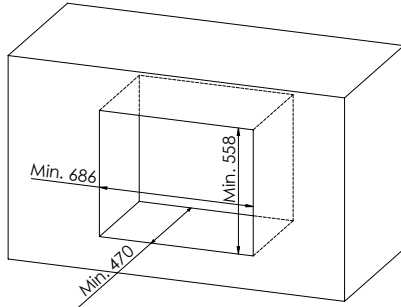

Classic 2

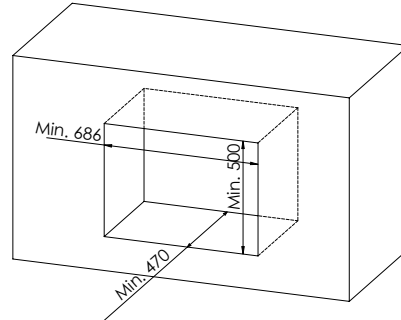

## Inspire

---

Inspire floor model and wall model

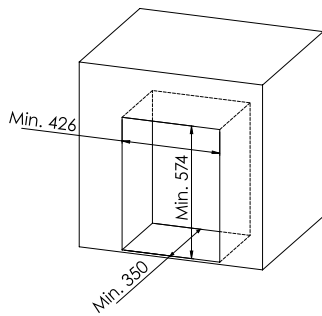

Inspire hidden wall model

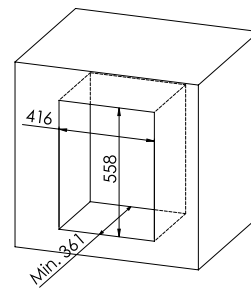

# Technical info

## Prestige A + B + C + Panorama + XL + Vista + S



Oven model	Prestige A	Prestige B	Prestige C	Panorama + XL	Vista	Vista S	Options
mm	 A: 294 B: 752 D: 463 H: 501	 A: 295 B: 731 D: 480 H: 501	 A: 294 B: 710 D: 480 H: 501	 A: 209 / 162 B: 778 / 1038 C: 317 / 314 D: 437 / 736 H: 647	 A: 291 / 304 (30°) B: 748 C: 439 (30°) D: 450 H: 543	 A: 198 / 203 (30°) B: 748 C: 444 (30°) D: 357 H: 450	 Paint black/grey
Floor to top outlet mm	-	-	-	-	-	-	
Energy efficiency class	A	A	A	A	A+	A	
Nominal kW	8,5	8,5	8,5	7,2 / 9,9	7,4	5	
Weight kg	105	100	104	114 / 146	106	88	
Fuel volume kg	2,1	2,1	2,1	1,9 / 2,3	1,76	1,25	
Combustion chamber width mm	614	614	614	548 / 462 XL 808 / 730	544	440	
Distance to flammable materials At the sides mm Behind stove mm	400 150	400 / 550 150	550 -	- -	110 150	300 75/130	
Distance to furniture mm	1100	1100	1100	1100 / 1200	1100	1100	
Efficiency Ecodesign requirement of 75%	79	79	79	80 XL 81	81	79	
Dust measurement Ecodesign requirement of 40 Mg/Nm³ 13% O₂	24	24	24	21 XL 17	13	22	

### Details



Craftsmanship



Air regulation



Integrated control handles





Optimal combustion

More on heta.dk

## Technical info

### Classic 1 + 2 + Inspire 40 wall + floor

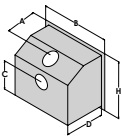
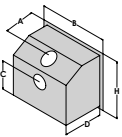
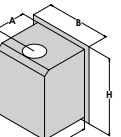
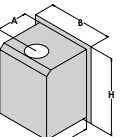

Oven model	Classic 1	Classic 2	Inspire 40 wall	Inspire 40 floor	options
mm	 <p>A: 313 / 333 (30°) B: 735 D: 453 H: 601</p>	 <p>A: 318 / 340 (30°) B: 735 D: 458 H: 543</p>	 <p>A: 229 / 289 (45°) B: 501 D: 345 H: 598</p>	 <p>A: 229 / 289 (45°) B: 481 D: 345 H: 578</p>	 Paint black/grey
Floor to top outlet mm	-	-	-	-	
Energy efficiency class	A+	A+	A+	A+	
Nominal kW	7,4	7,4	5	5	
Weight kg	95	89	67 → 80	67 → 80	
Fuel volume kg	1,7	1,7	1	1	
Combustion chamber width mm	510	510	330	330	
Distance to flammable materials					
At the sides mm	400	400	-	-	
Behind stove mm	-	-	210	210	
Distance to furniture mm	1200	1200	900	900	
Efficiency Ecodesign requirement of 75%	81	81	84	84	
Dust measurement Ecodesign requirement of 40 Mg/Nm³ 13% O₂	31	31	9	9	

## Details



Control handles



Handle



Different frames



Optimal combustion

More on hetadk

## Scan-Line 805 Aqua



*Scan-Line 805 Aqua  
soapstone top*

# Aqua oven

Scan-Line 805 Aqua has specially sealed stove glass, significantly reducing radiated heat in the room. The beautiful flame presentation and high 87% efficiency reflects the innovative development work.

Give free rein to your imagination and exploit what they have to offer. The Scan-Line 800 aqua series comes with a safety valve for connection to existing systems. When connecting the stove, please ensure it has the ideal circulation pump flow rate of 140 litres/hour and that the existing

system is equipped with a safety valve which activates if the water pressure exceeds 2.5 bar.

The optional aqua kit prevents corrosion in the heat exchanger, as the return flow temperature is increased via the thermal three-way valve (bypass). The continual adjustment of a constant return water temperature ensures smooth combustion and optimal energy utilisation.

The aqua kit is an optional extra and is not included in the stove price.



Scan-Line Aqua 805



Scan-Line Aqua 805 soapstone

## Technical info Scan-Line Aqua 805



∨

Options

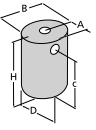
Oven model	Aqua 805
mm	 <p>A: 275 B: 576 C: - D: 506 H: 1216/1213</p>
Energy efficiency class	A+
Nominal kW	8,7
Weight kg	226 → 310
Distance to flammable materials	
At the sides mm	225
Behind stove mm	20
Distance to furniture mm	750
Efficiency	
Ecodesign requirement of 75%	87
Dust measurement	
Ecodesign requirement of 40 Mg/Nm <sup>3</sup> 13% O <sub>2</sub>	24

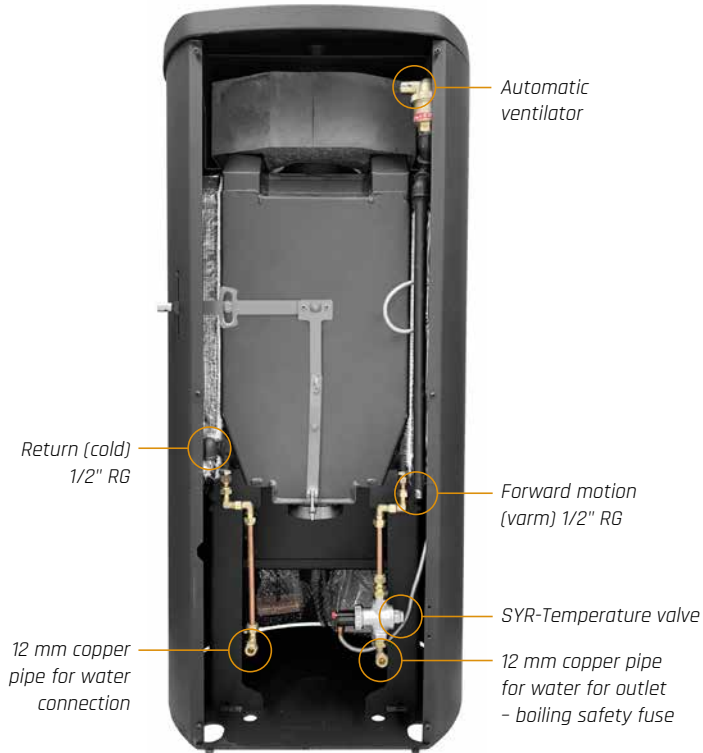

Optimal combustion

# HETA Automatic Combustion

HETA makes it easy to fire correctly with HETA Automatic Combustion. The automatically-controlled air supply means that you just have to add wood to your stove to achieve optimum combustion. After filling up, HETA Automatic Combustion tells you when to fire again.

The module can be set to three different temperature levels. When HETA Automatic Combustion is set at a temperature level, the stove burns optimally - fully automatically.

You get a detailed overview of the combustion with HETA Automatic Combustion. The module is built into the stove and has a freestanding display giving you all the information you need.



*HETA Automatic Combustion is available for Scan-Line 8, 500, 800, 900, 1000, 80, 40/50, 10-20-30.*

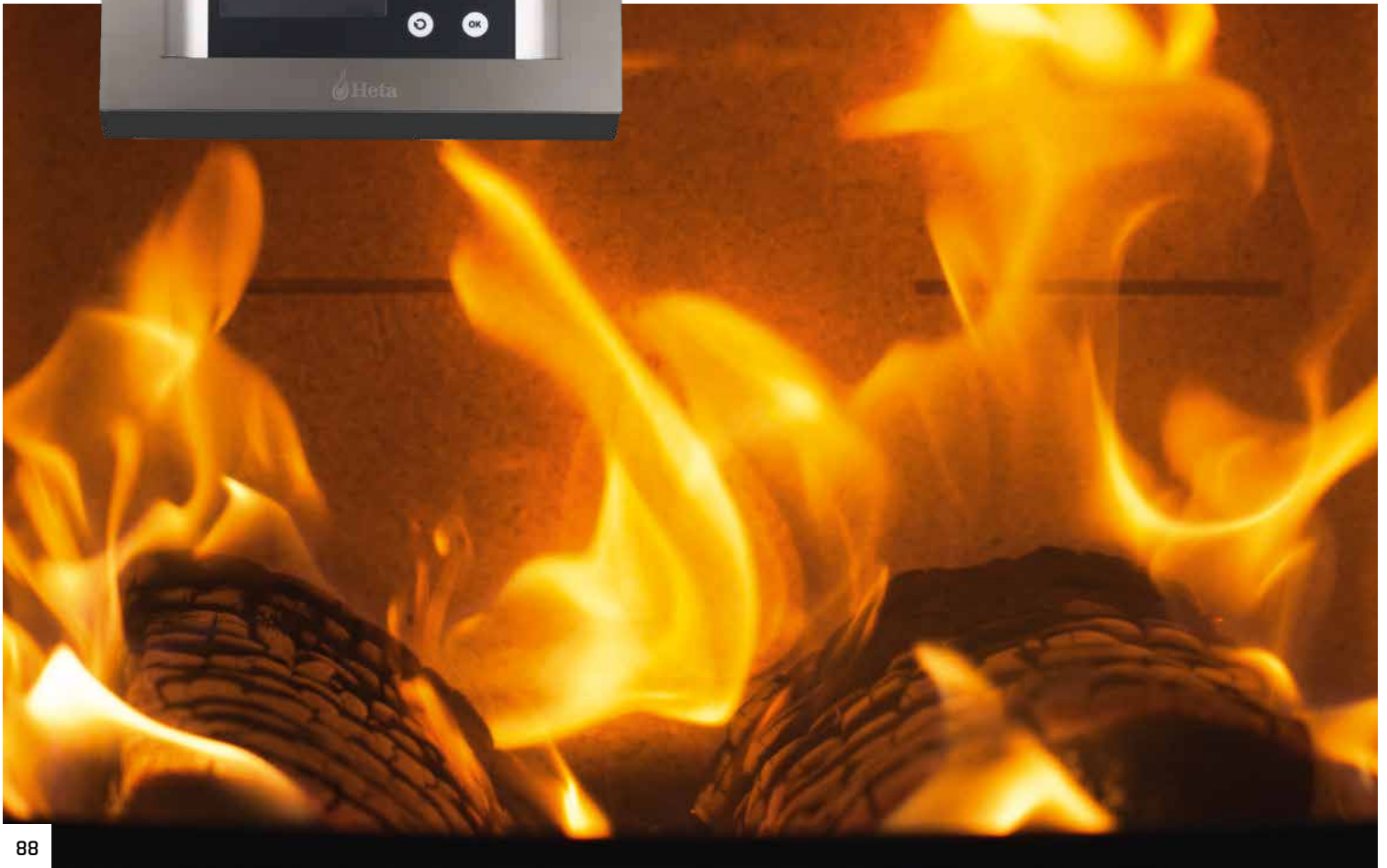

## Firewood baskets



Ø50 x H30 cm



Ø40 x H30 cm



Ø30 x H30 cm



Ø35 x H20 cm

## Accessories



### Fresh air kit

External wall pipe and vent, 1.5 m flex pipe. Insulation, heat tape, 2 clamps.



**Graphite spray**  
for lubrication.



### Glass cleaner

HETA's glass cleaner is specially formulated to not harm your glass, while making it easy to clean.



### Swivel plates

HETA's turntable plates gives you the ability to view your stove 120, 180 or 360 degrees.



### Door, gasket set

If the door in the stove does not seal properly it must be replaced. This is easy to do using this set which includes both gasket and glue.



### Senotherm spray paint

Refresh the stove. It is easy to repair small damages in the colour using Senotherm spray paint to make your stove look fresh and nice again. Senotherm spray paint tolerates heat and is easy to use.



### Thermometer

Helps you to keep track of the heat in the baking oven.



### Grill for baking stove

A perfect fit for your baking oven.



**Tipi**  
HETA Tipi provides comfortable warmth on cool summer evenings.



**Tipi grill**  
Use the grill for cooking in Tipi 147 cm - e.g. for grilling sausages.

**More on  
heta.dk**

## Glass plates

**Scan-Line 900**  
0021-014465

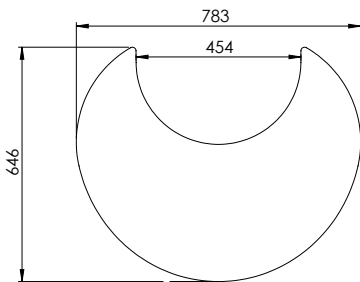

**Scan-Line 8**  
1013-011481

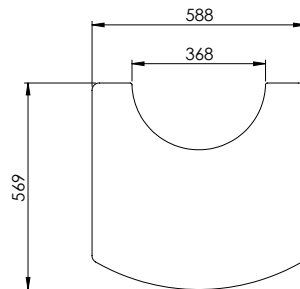

**Scan-Line 8**  
3535-0103

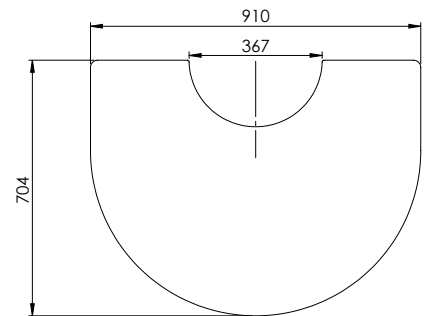

**Scan-Line 900**  
0021-014873

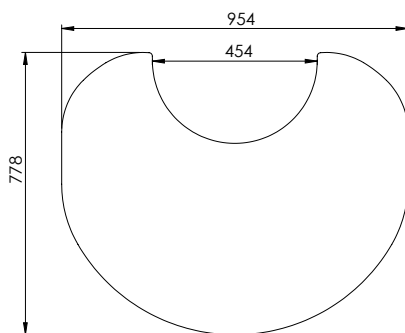

**Scan-Line 1000**  
3535-0105

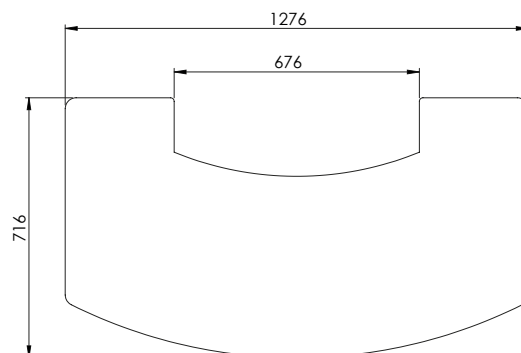

---

**Scan-Line 7B (Log Store),  
Scan-LineGreen 150,  
Scan-LineGreen 250**  
0021-026111

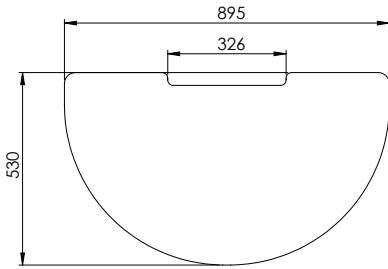

**Scan-Line 7B (Log Store),  
Scan-LineGreen 150,  
Scan-LineGreen 250**  
0021-014466

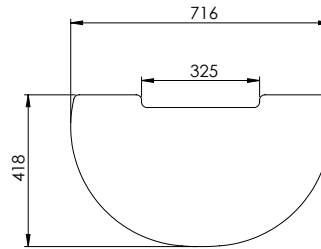

---

**Scan-Line 800, Scan-Line 810,  
Scan-Line 820, Scan-Line 830, Scan-Line 840,  
Scan-Line 80XL-80XLB, Scan-Line Green 250, Scan-Line  
805 Aqua, Scan-Line Green 250, Scan-Line 805 Aqua**  
3535-0100

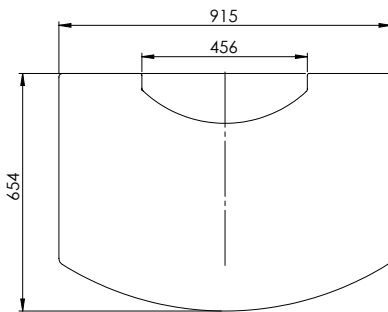

**Scan-Line 500, Scan-Line 510,  
Scan-Line 520, Scan-Line 550,  
Scan-Line 551, Scan-Line 560,  
Scan-Line 590**  
3535-0101

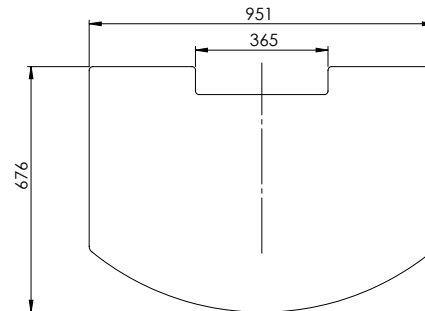

---

**Modern Universal**  
3535-0104

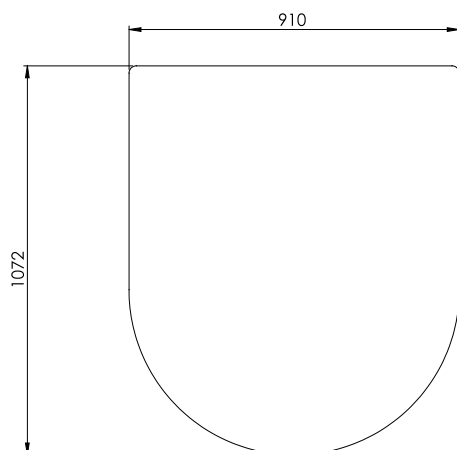

**Classic Universal**  
3535-0102

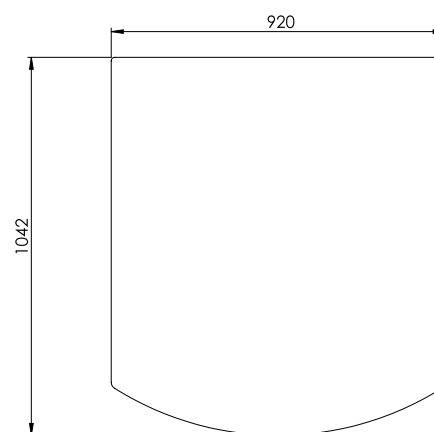



042025 Print: reklametryk.dk Photo: HETA



We take pride in delivering high quality products for all your heating needs. From an idea to a finished product in your home. On the west coast of Denmark, with the North Sea and raw nature surrounding us. This is where each of Heta's wood, pellet and aqua stoves are designed, developed and made.

Jupitervej 22 | DK-7620 Lemvig | [heta.dk](http://heta.dk)

Dealer